

DX-703

v. 2006.05

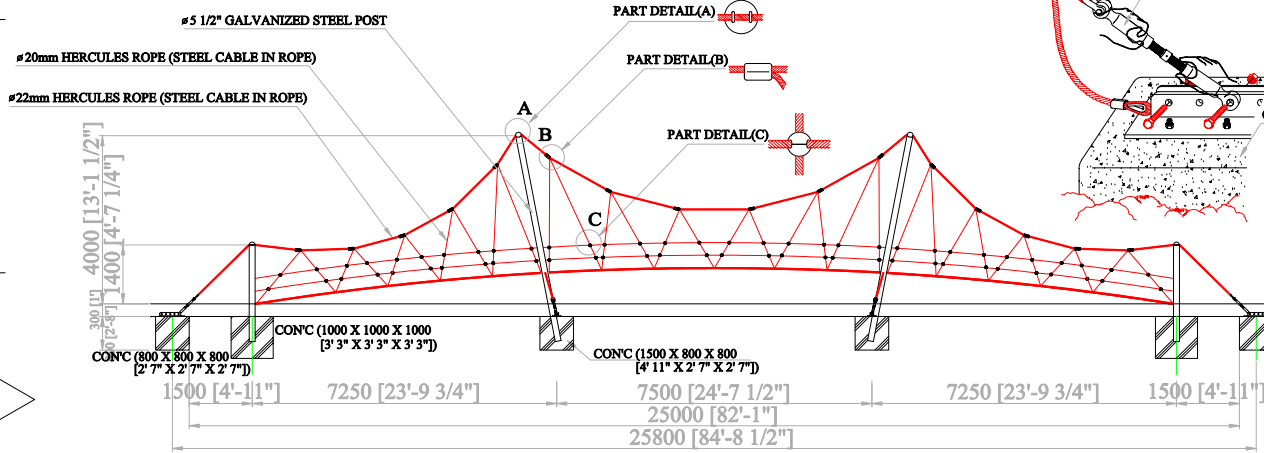

FRONT VIEW

SCALE 1/60

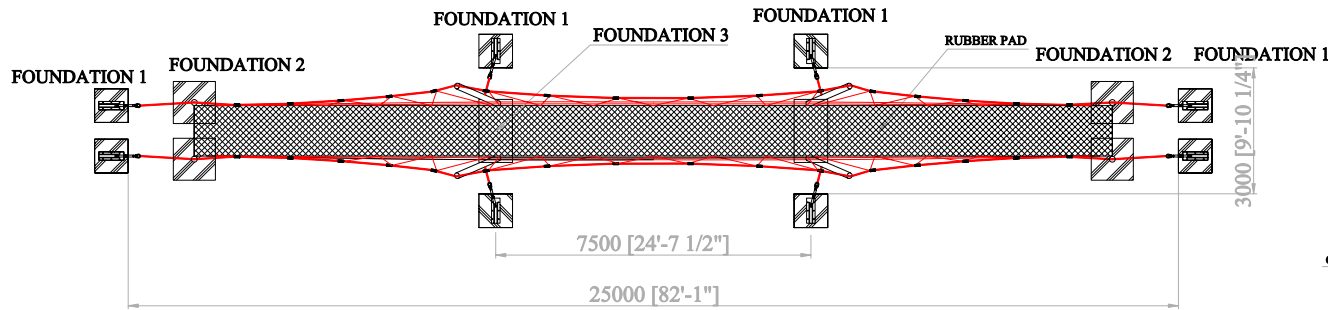

LAYOUT DRAWING

SCALE 1/60

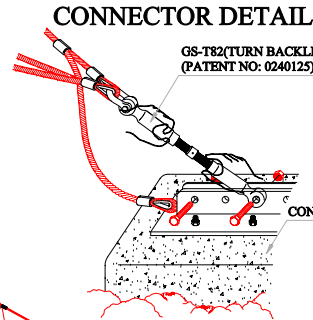

FOUNDATION 1 DETAIL (SIDE VIEW)

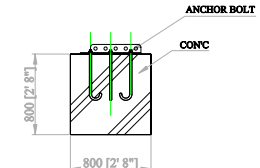

FOUNDATION 1 DETAIL (PLAN)

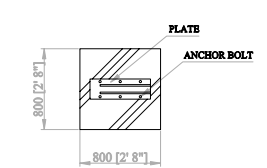

FOUNDATION 2 DETAIL (SIDE VIEW)

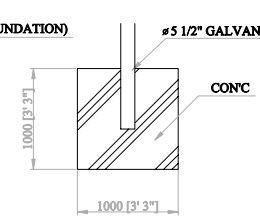

FOUNDATION 2 DETAIL (PLAN)

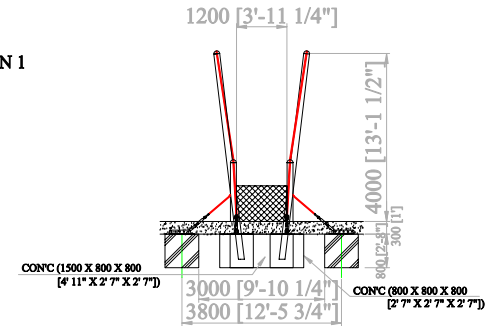
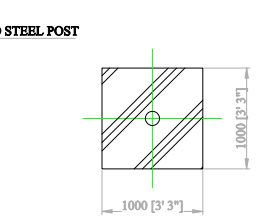

SIDE VIEW

SCALE 1/60